



Installation Procedure

Watson Bowman Acme Corp. 95 Pineview Drive Amherst, NY 14228

phone: (716) 691-7566 fax: (716) 691-9239

website: www.wbacorp.com

Information provided herein, including but not limited to, any drawing, design, photograph, graphic, or statement(s) ("Materials") are proprietary and the property of Watson Bowman Acme Corporation ("Company"). Reproduction, translation, or reduction to any electronic medium or machine readable form, in whole or part, is strictly prohibited, except for the express purpose for which it has been furnished, without prior written consent of Company. All Materials contained herein are provided by Company for information purposes only. Company reserves the right to amend or withdraw any information contained in the Materials without notice. All technical or other advice by Company, whether verbal or written, concerning products, or the use of products in specific situations ("Advice") is given by Company and is used at the Users own risk.

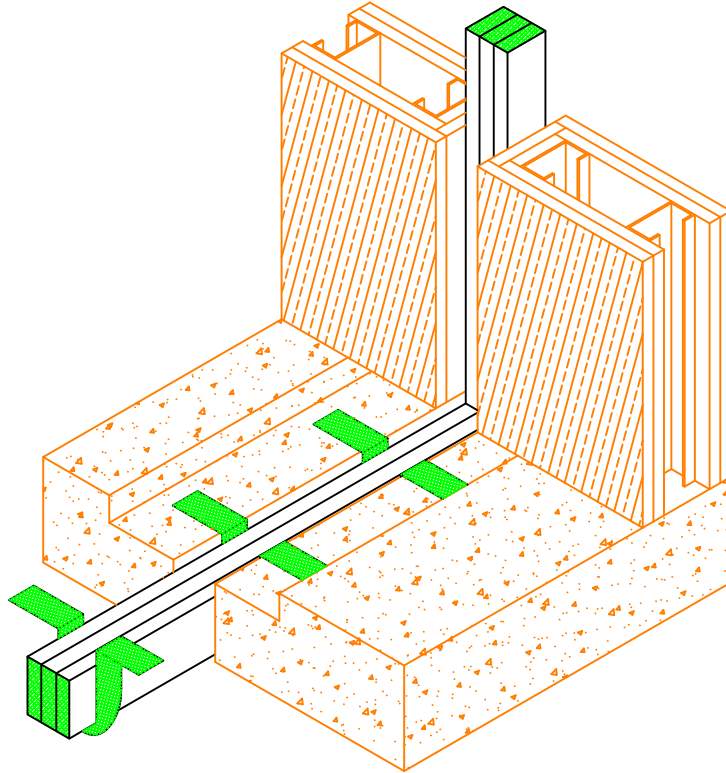

Wabo®Thermoshield - Life Safety Series Model(s) "HTS" & "VTS" Fire Barrier Systems

The following installation procedure is very important and must be fully understood prior to beginning any work. To ensure proper installation and performance of expansion joint system the following actions must be completed by the installing contractor. Failure to do so will affect product warranty.

- 1) Carefully read and understand installation procedure. Contact WBA's Technical Service Department at (800) 677-4922 for product assistance.
- 2) Inspect all shipments and materials for missing or damaged components and hardware. Contact Customer Service at (800) 677-4922 with WBA's order number and invoice for prompt assistance.
- 3) Inspect substrate or adjacent construction for acceptance before beginning work. Report unacceptable construction to the project manager for scheduled repair work.
- 4) Review WBA shop drawings for project specific detailed information if Engineering services were purchased at time of order.

Standard Components

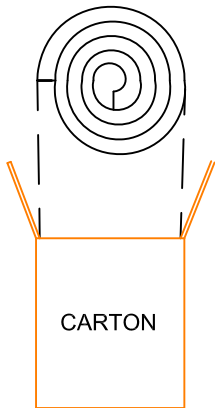
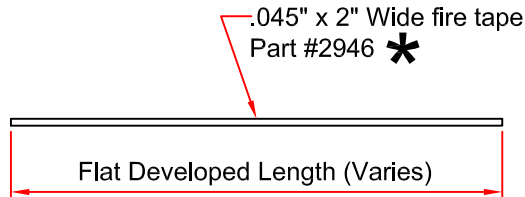

1" x 5" Encapsulated Coils
(P/n: 3029)

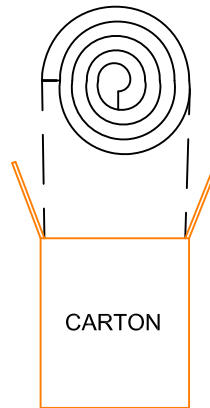

1/2" x 5" Encapsulated Coils
(P/n: 3028)

Components shown below vary in size depending on model of system

Watson Bowman Acme Corp.
95 Pineview Drive Amherst, NY 14228
phone: (716) 691-7566 fax: (716) 691-9239
website: www.wbacorp.com

Installation procedure: Thermoshield Fire Barrier
Watson Bowman Acme Corp. reserves the right to amend or withdraw any information contained herein without notice and will not be responsible for any inaccuracy or ambiguity of any information contained herein.



* Components required for Horizontal condition installation.

Installation Procedure

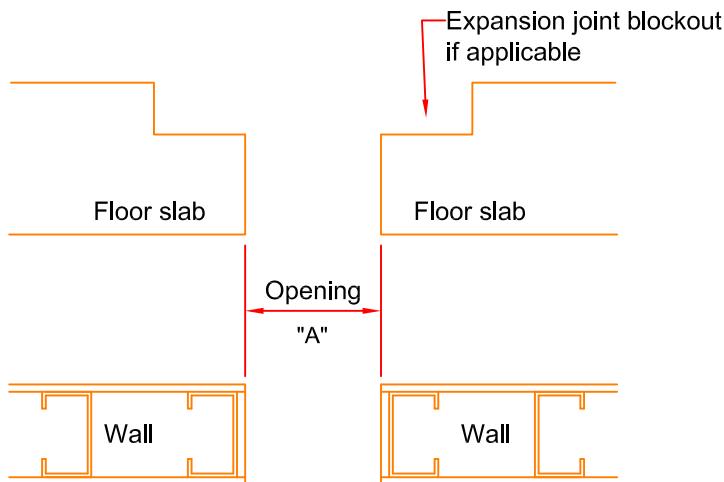

1

Prepare and/or inspect opening as indicated on the shop drawing or manufacturers literature. Correct all imperfections that may affect proper installation of thermoshield fire barrier system. Discrepancies or variations in the opening shall be brought to the attention of Watson Bowman Acme prior to the installation of any material.

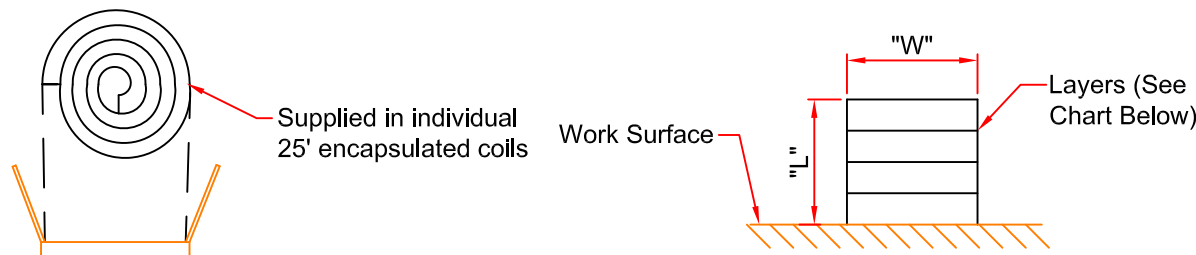

"W" - denotes width of Material and determines Fire Rating (Typ - 5")

"L" - denotes number of layers to be installed in opening based on total design movement

Model # (*)	Layers of p/n: 3028	Layers of p/n: 3029
HTS-0.75 & VTS-0.75	1	1
HTS-1 & VTS-1	-	2
HTS-1.5 & VTS-1.5	1	2
HTS-1.75 & VTS-1.75	0	3
HTS-2 & VTS-2	1	3
HTS-2.5 & VTS-2.5	-	4
HTS-2.75 & VTS-2.75	1	4
HTS-3 & VTS-3	-	5
HTS-3.5 & VTS-3.5	1	5
HTS-3.75 & VTS-3.75	0	6
HTS-4 & VTS-4	1	6

* - HTS models have a fire rating to 3hrs and VTS has a fire rating to 2hrs.

2

Unpackage Wabo®Thermoshield from original manufacturers carton and stack or assemble the specified number of thermoshield layers on a suitable work surface in preparation for insertion into the expansion joint opening.

Note: The Thermoshield blanket material shall arrive at the jobsite factory cut to predetermined widths based on the required fire rating. The number of layers installed into the expansion opening has been predetermined and is based on the expected maximum width of the expansion opening due to movement.

Installation procedure: Thermoshield Fire Barrier
Watson Bowman Acme Corp. reserves the right to amend or withdraw any information contained herein without notice and will not be responsible for any inaccuracy or ambiguity of any information contained herein.



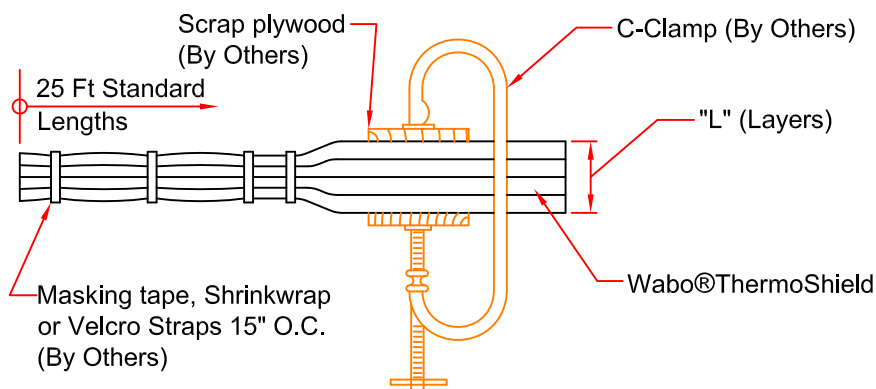

3

Using C-clamps and sections of plywood, compress ThermoShield and wrap with one layer of masking tape or other at approximate intervals of 15 inches. This will pre-compress the material and provide for a smooth and efficient installation process.

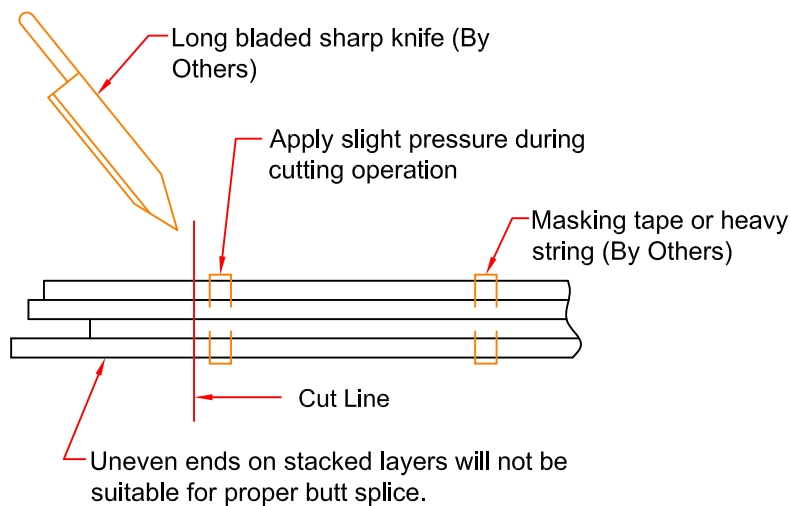

4

The contractor shall field cut the assembled stack of ThermoShield layers to the length required for installation. The cut shall be true, square and smooth and will form one of the ends that will be used in properly completing a field butt splice.

Note: It is recommended that cut lines be located just to the right or left of the tape. This will maintain material alignment & compression necessary to complete a proper butt splice.

Installation procedure: ThermoShield Fire Barrier
Watson Bowman Acme Corp. reserves the right to amend or withdraw any information contained herein without notice and will not be responsible for any inaccuracy or ambiguity of any information contained herein.



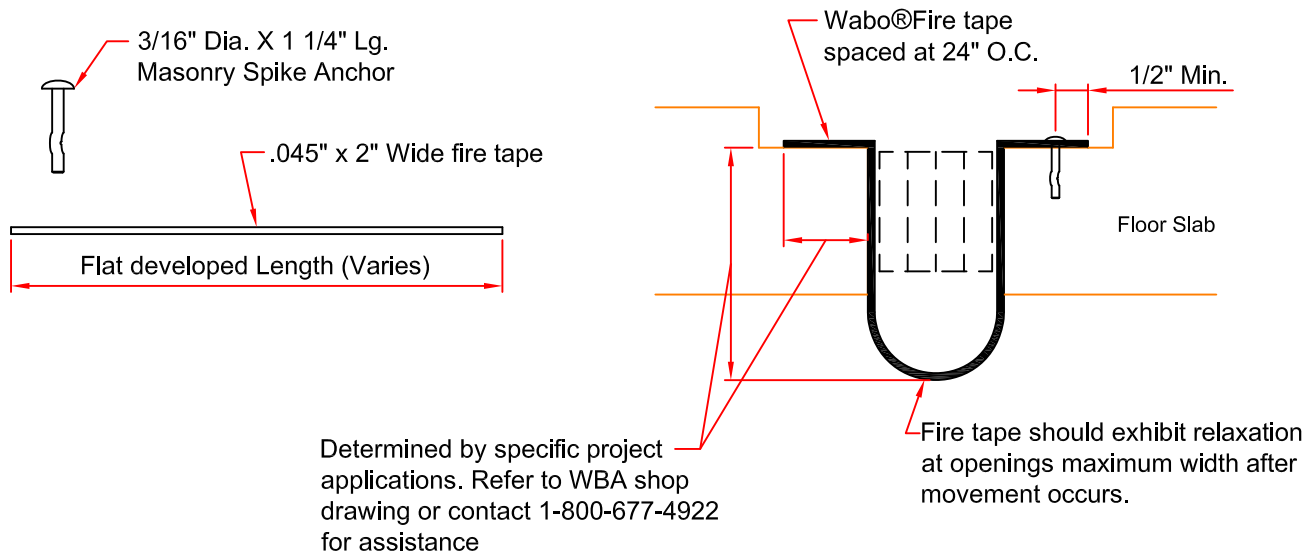

5

Horizontal applications only:

Prior to inserting Thermoshield, the contractor shall install .045" thick by 2" wide wabo fire tape at 24" O.C.(maximum spacing) into the expansion opening. The tape shall be secured to the base of the concrete blockout by utilizing 3/16" dia. Spike anchors. The contractor shall ensure that the material is properly draped into the expansion joint opening to allow for proper installation of the Wabo "Thermoshield" fire barrier.

Note: Wabo@Fire tape is supplied in rolls to the project site. Based on project requirements short lengths are cut from the factory roll utilizing a pair of standard scissors.

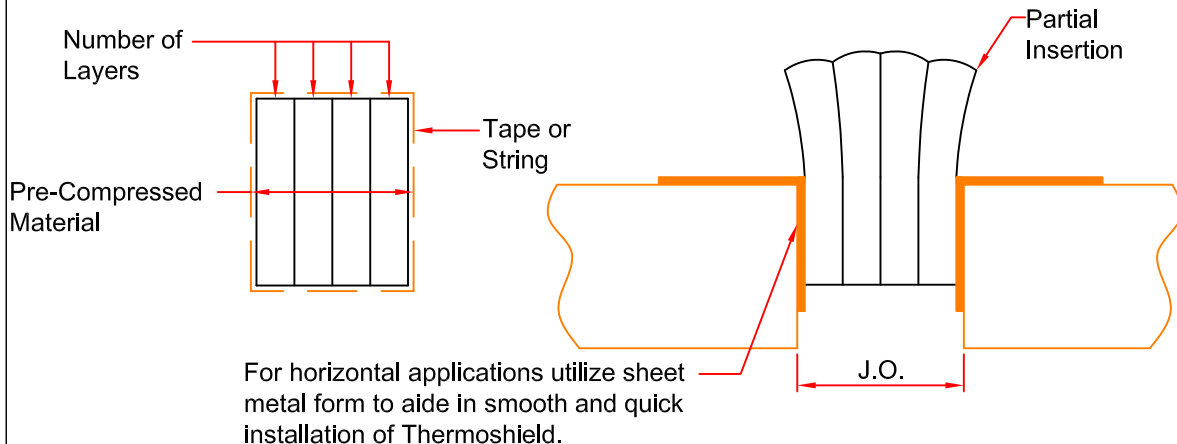

6

Review shop drawing or product application to determine proper recess of thermoshield fire barrier

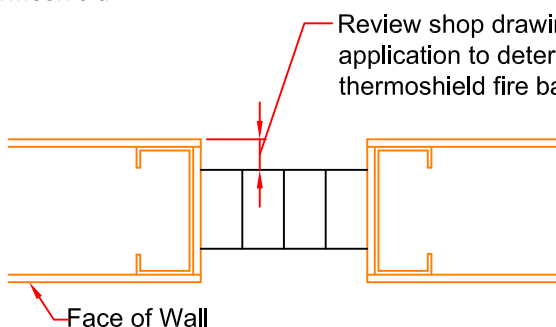

Typically, the corner at the edge of the concrete slab is rough. To aid in the installation of the Thermoshield material, it is recommended to form an I-shaped thin gauge sheet metal profile approximately 8 to 10 feet long. One will be required for each side of the expansion joint opening. Seat the sheet metal profiles on the edge of the concrete slab and begin to insert material. The depth at which the material is inserted into the expansion opening will be determined by the requirements of the expansion joint assembly as detailed on the shop drawings. If no requirements exist, center the material in the floor or wall opening.

Note: It is critical that the Wabo@Thermoshield be installed into the expansion opening in the proper orientation. For verification, the installer shall ensure that the number of layers installed can be measured across the width of the opening. The width at which each layer was factory cut shall extend vertically into the joint opening.

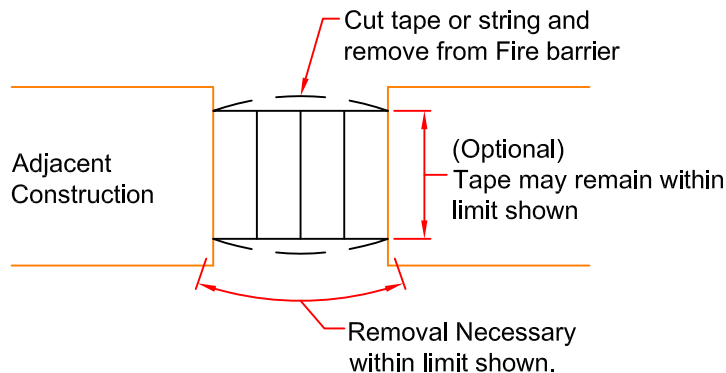

7 Using a utility knife, cut and remove masking tape or other to prevent restricted movement of fire barrier. If masking tape was utilized it may be necessary to remove tape from both sides of fire barrier.

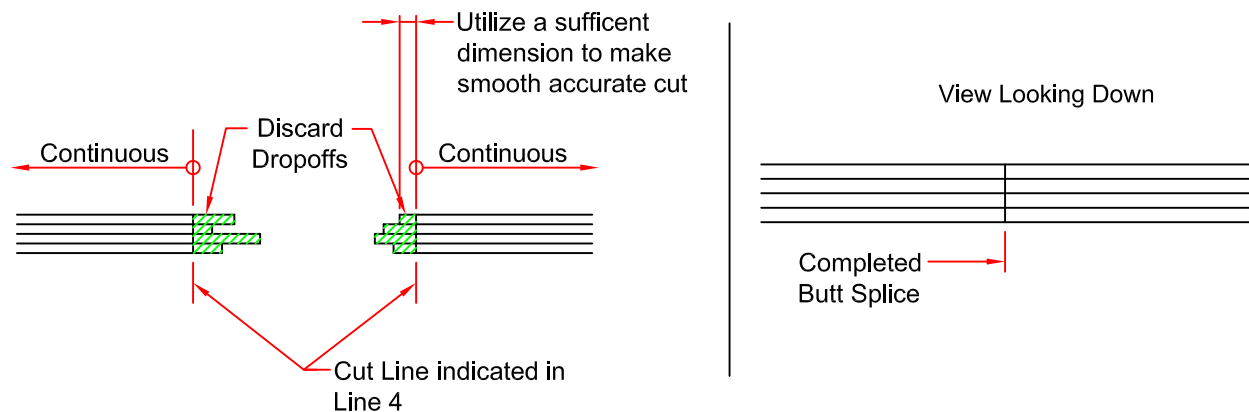

8 The contractor shall be responsible for completing a square butt splice. Join assembled layers of material with a smooth square cut by simply butting the material (using no adhesives) to the square end of the material previously installed. The contractor shall ensure that the butt splice is closed tight showing no signs of light filtering through the splice area.
Note: Refer to Step 4 for review of ThermoShield cutting procedure.

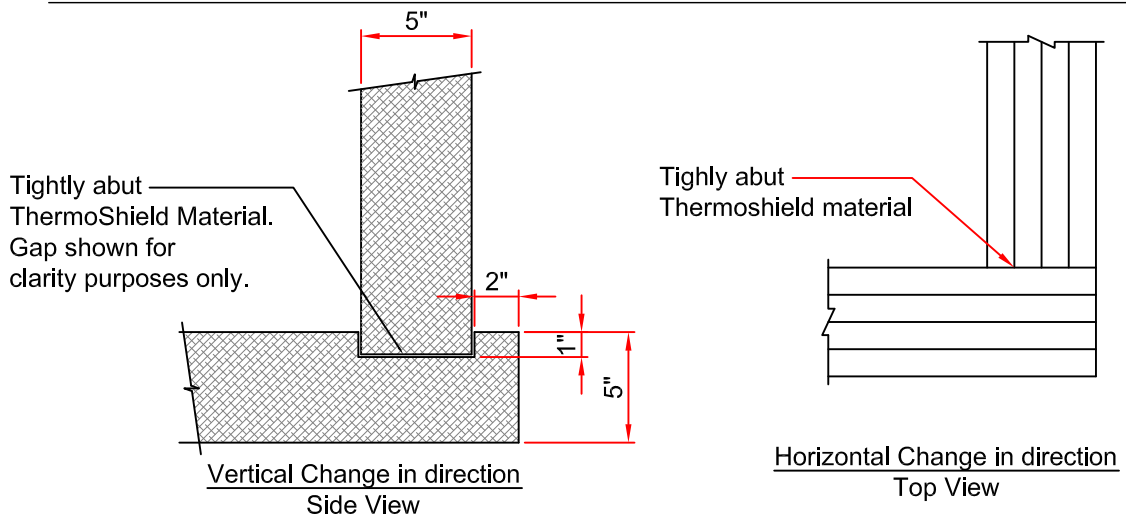

9 Utilizing procedure to properly achieve a butt splice, prepare ends of ThermoShield fire barrier as shown in diagram to accommodate changes in direction. Inspect all splices to ensure that all material abuts tightly showing no signs of light filtering through from the opposing side.

10 For installation of subsequent sections of Wabo®ThermoShield materials, repeat steps 2 through 8.